

Installation

S19-210BSS

Stainless Steel Pedestal-Mounted Eyewash

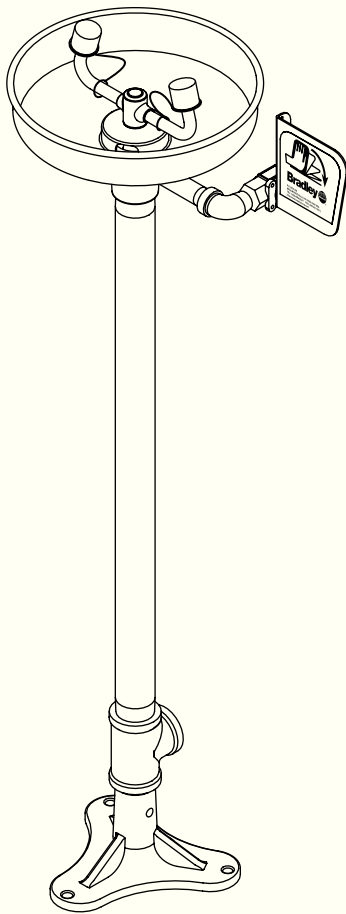
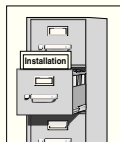

Table of Contents

Pre-Installation Information	2
Installation	3
Assembly of Components and Parts List	4

[Bradley S19 210bss Eyewash All Stainless Steel](#)

 **WARNING** 



Read this installation manual completely to ensure proper installation, then file it with the owner or maintenance department. Compliance and conformity to drain requirements and other local codes and ordinances is the responsibility of the installer.



Separate parts from packaging and make sure all parts are accounted for before discarding any packaging material. If any parts are missing, do not begin installation until you obtain the missing parts.

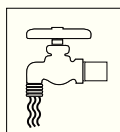

Flush the water supply lines before beginning installation and after installation is complete. Test the unit for leaks and adequate water flow. Main water supply to the eyewash should be “ON” at all times. Provisions shall be made to prevent unauthorized shutoff.

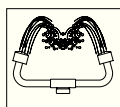

The ANSI Z358.1 standard requires an uninterrupted supply of flushing fluid. Bradley plumbed emergency fixtures require a minimum of 30 PSI (0.21 MPa) flowing pressure. Flushing fluid should be tepid per ANSI Z358.1.

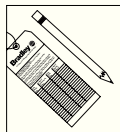

The inspection and testing results of this equipment should be recorded weekly to verify proper operation. This equipment should be inspected annually to ensure compliance with ANSI Z358.1.



Workers who may come in contact with potentially hazardous materials should be trained regarding the placement and proper operation of emergency equipment per ANSI Z358.1.



Installation

Supplies Required:

- (3) $\frac{3}{8}$ " floor anchors and bolts
- Pipe sealant
- Piping to $\frac{1}{2}$ " NPT water supply inlet
- Piping to $\frac{1}{4}$ " NPT drain outlet
- Sign-mounting hardware

NOTE: Local codes may require the installation of a backflow prevention valve to complete proper installation. Compliance with local codes is the responsibility of the installer. Valve must be tested annually to verify that it is functioning properly. Backflow prevention valves are not included with the fixture and may be supplied by the contractor or purchased from Bradley Corporation.

Step 1: Secure base to floor

1. Install three suitable anchors (supplied by installer) for $\frac{3}{8}$ " bolts in the floor.
2. Bolt the base to the floor anchors using $\frac{3}{8}$ " bolts (supplied by installer).

Step 2: Assemble eyewash

1. Assemble eyewash components as shown on page 4.
 - Apply pipe sealant (supplied by installer) to all male-threaded pipe joints.
 - Use the rubber grip pad provided or a strap wrench around pipes when tightening to prevent marring. Place the grip pad on the pipe, then put the wrench over the grip pad and turn the pipe with the wrench.

Step 3: Connect water supply

1. Connect the water supply piping (supplied by installer) to the $\frac{1}{2}$ " NPT inlet on the eyewash.
2. Connect the drain piping (supplied by installer) to the $\frac{1}{4}$ " NPT drain outlet on the eyewash.
3. Mount the safety sign to the wall using sign-mounting hardware (supplied by installer).
4. Open the water supply lines and test for leaks and adequate water flow.

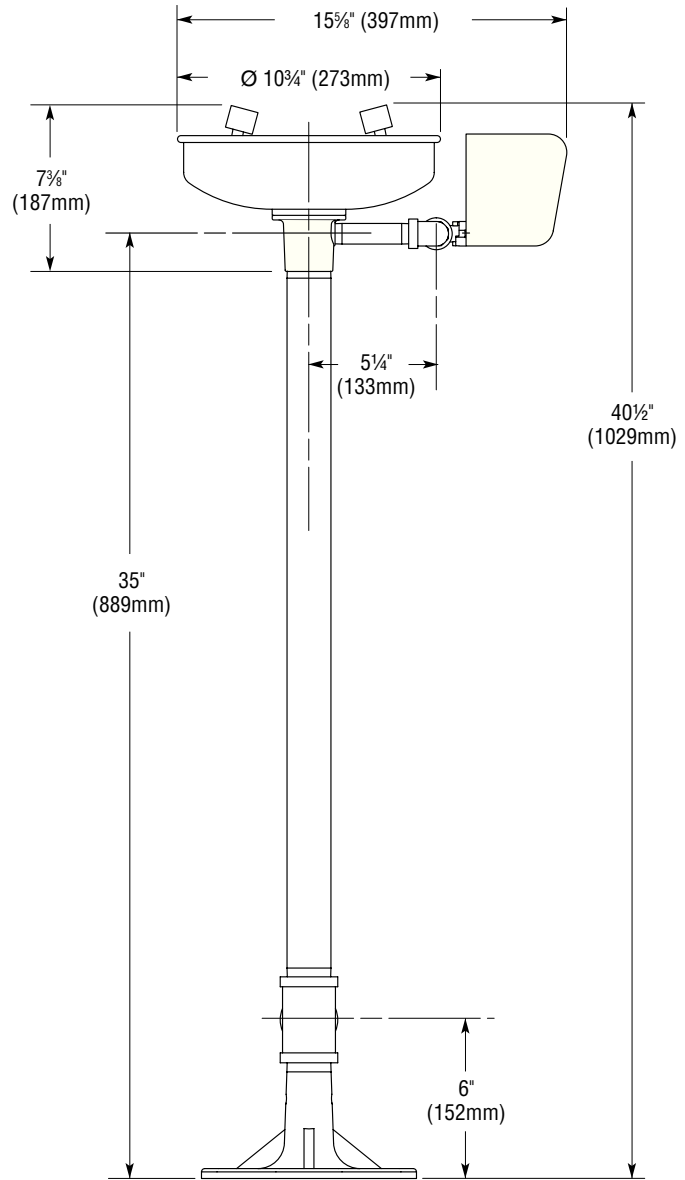

NOTE: All dimensions assume standard thread engagement. Variations in manufacturing allow for $\pm \frac{1}{8}$ " (3mm) per threaded joint. To find the tolerance of a dimension, add the number of thread joints in between a dimension and multiply it by $\frac{1}{8}$ " (3mm).

Assembly of Components and Parts List

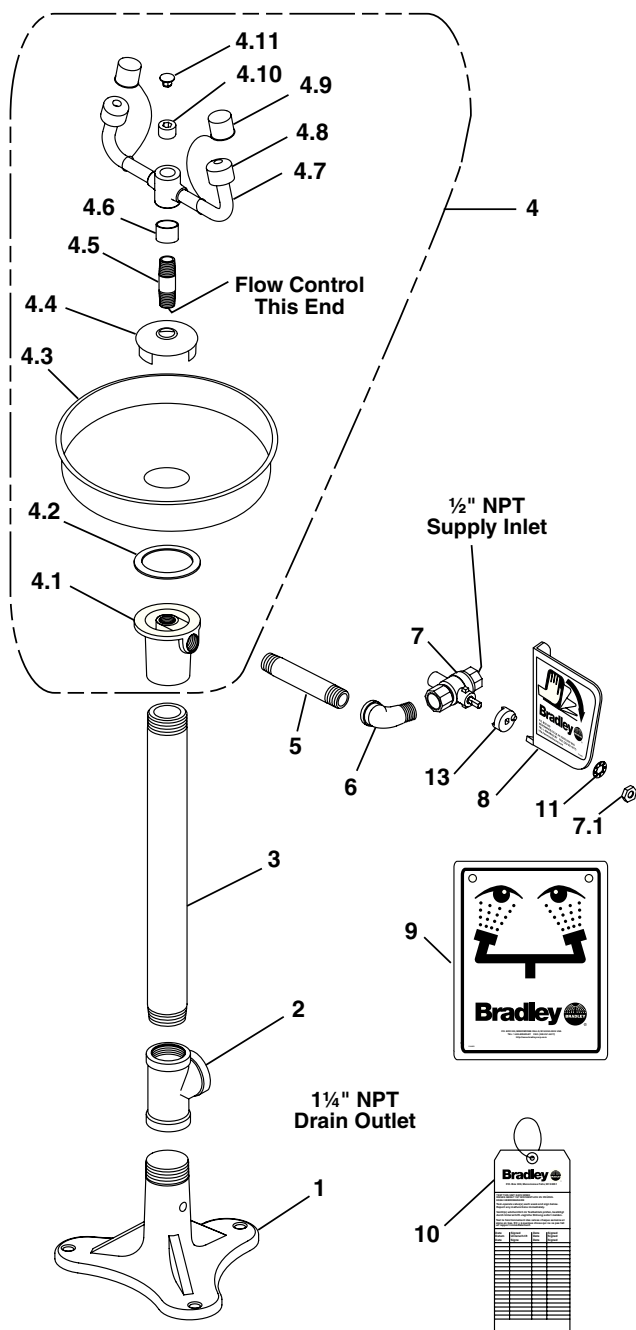

Item	Part No.	Qty	Description
1	131-062	1	Base
2	269-237	1	Pipe Tee, 1 1/4"
3	113-584	1	Pipe, 1 1/4" x 26 1/2"
4	S90-363	1	Eyewash Assembly
4.1	111-049	1	Inlet Drain Fitting
4.2	124-028	1	Center Seal Gasket
4.3	187-053	1	Stainless Steel Bowl
4.4	173-009	1	Cup Strainer
4.5	S21-072	1	Supply Pipe
4.6	113-1159	1	Spacer, Drain
4.7	S05-131	1	Eyewash Yoke
4.8	115-141	2	Sprayhead
4.9	107-371	2	Tethered Dust Cover
4.10	153-333	1	Pipe Plug
4.11	269-874	1	Cap Plug
5	113-965	1	Pipe, Stainless Steel 1/2" x 3 1/2"
6	269-241	1	Street Elbow 1/2"
7	S27-328	1	1/2" Ball Valve w/Nut
7.1	110-248	1	Nut 316 Stainless Steel
8	S08-336	1	Flag Handle Assembly
9	114-051	1	Safety Sign
10	204-421	1	Emergency Inspection Tag
11	142-002DA	1	Washer
12	269-915	1	Grip Pad (not shown)
13	153-372R	1	Adapter

Prepack S45-1787 includes Items 4.2, 4.4, 4.5, 4.6

Prepack S30-109 includes Items 7, 8, 11, 13

For proper handle and ball valve kits, refer to instruction sheet 215-1774.

NOTE: Items 4.1–4.11 come preassembled as Item 4.